

## CNC Solutions

### For laser cutting machines

- Simple and fast integration
- High performance
- Ease of use



# CNC solutions

## By Inovance



Inovance Technology Europe's headquarters in Stuttgart, Germany

Inovance Technology Europe is the European division of global industrial automation group Inovance. Formerly known as Power Automation, Inovance Technology Europe has more than 20 years of extensive CNC expertise across milling and cutting applications. The company specialises at delivering real-time machine control, and at helping OEMs to improve machine performance and productivity.

With its network of offices and R&D facilities in Germany, France, Italy, Spain and Turkey, Inovance Technology Europe is able to offer local service and support right across the European continent. Inovance has invested heavily in its European CNC R&D centre, and the company has a large engineering research team based in Germany, supported by a network of technical experts based across Europe.

To learn more about Inovance Technology Europe and about Inovance – a \$2.7bn+ global industrial automation company offering the full range of industrial automation products from variable speed and servo drives, to PLCs to industrial IoT solutions – visit [www.inovance.eu](http://www.inovance.eu)



Inovance Technology Europe - CNC Technology Centre

## Laser cutting with Inovance

Inovance offers a CNC solution for all kinds of laser cutting machines – from simple 2-axes applications to 3D bevel cutting machines.

With our solution you get a perfectly suited package of hardware and software – from one source. All the relevant functions for cutting are included – no additional options are required for running a cutting machine.

The extensive software package consists of the fully integrated state-of-the-art PA HMI programming and operating software, a pre-programmed PLC and all dedicated CNC functions.

The solution is designed to guarantee efficient operation of your laser cutting machine.

### Your advantages

- All the relevant cutting functions are included
- Simple and fast integration
- Freedom to extend or change our standard package according to your needs and requirements
- Generic PLC included
- Easy operation
- High performance
- Fast machine start-up
- Predictable start-up and running costs
- Rapid time to market
- A one stop shop





## Software functions For laser cutting

### Peripherals

The following laser sources are integrated into the PLC's logic

- IPG / IPG EtherCAT
- nLight
- Max / Max EtherCAT
- SPI EtherCAT
- Others on request

The following laser cutting heads are supported:

- Precitec (also EtherCAT)
  - Light cutter
  - Pro cutter
  - Zoom head
- Motorized focus and spot size controls for the above-mentioned manufacturers
- Others on request

### Other peripherals

- Integrated gas handling
  - Support for N<sub>2</sub>, O<sub>2</sub>, high pressure N<sub>2</sub> and compressed air
  - Automatic pressure regulation
  - Various functions to maintain stable and clean gas supply such as purging
  - Tolerance checks, min/max check
- Shuttle tables for loading and unloading
  - Manual and automatic shuttle tables
  - Support of different types with external logic
  - Integrated logic to support different logics without additional (external) controller system
- Integrated doors logic to open/close doors with hydraulic or PLC controlled axes
- Sheet storage/loader systems
  - Possibility to integrate different loader/storage systems
- Exhaust handling system ensures only the necessary exhausts run while the laser head is cutting
- Extraction handling, safe handling of doors
- Conveyor handling (parts are moved out of the machine)
- Clamp handling with automatic clamp opening/closing to avoid collisions
- Head cooling function to avoid overheating of the cutting head

### CAD/CAM and Postprocessors

We already work with the following CAD/CAM manufacturers:

- Lantek
- Radan
- Metallix
- Others on request

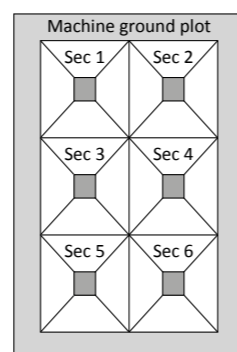
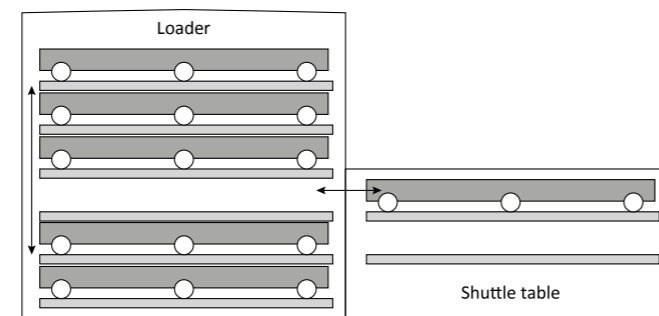
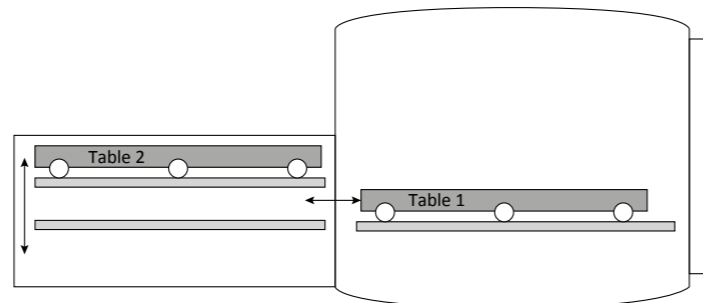

## Machine functions For laser cutting

### Machine functions

- Marking
- Film burning (burning of existing foil cover before cutting)
- Piercing functions
  - Predefined piercing from database
  - Piercing with modulated laser output
  - Ramping (dynamic and static change of piercing values) e. g. for thick materials
  - Adapted height sensing during piercing
  - High piercing: piercing outside of the height control sensor range
  - Circular/static piercing
- Bypass material spot problems
  - Different strategies to avoid influence of spotting material on the nozzle/sensor
- Dynamic Micro-Joint
  - Avoidance through adjusting the cutting path to generate overlaps
  - Generation through adjusting the cutting path to generate gaps
  - The advantage is that it is much more precise than if it was done by CAD/CAM
- Plate determination/detection (start position, angle and size)
  - Automatic operation: At the start of each job, the plate determination program can be executed automatically
  - This is the most precise way to do it
  - Semi-automatic operation: Manually, for example by setting the position by laser pointer
  - Manual operation: Manually by setting the angle and start position

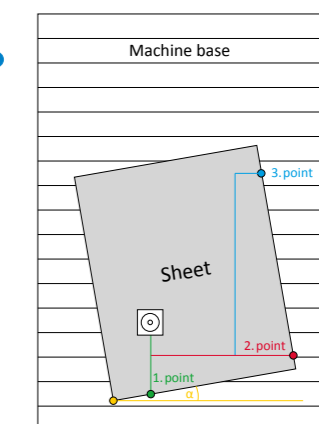
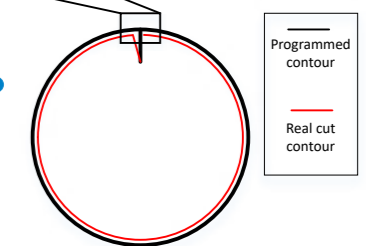
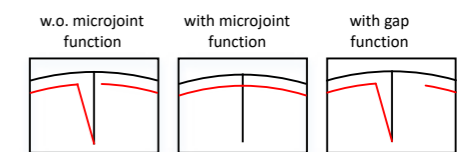
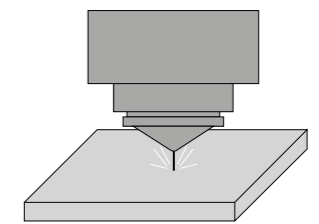
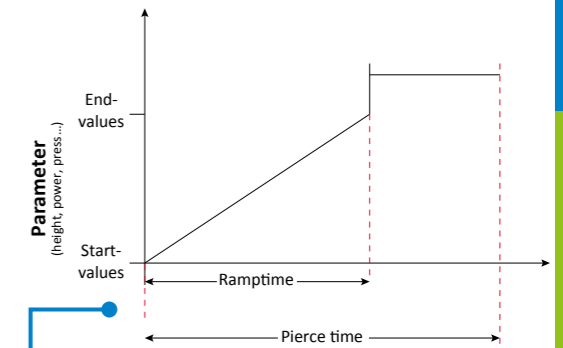

## Machine functions For laser cutting

### Machine functions

- Internal/external laser pointer function for calculating the start-point
- Online change of gas pressure and focal position
- Safe-Stop of NC process: During the cutting process there could be reasons why the NC-Program needs to be interrupted. In that case, the following functions are available:
  - Moving manually backward on the contour
  - Moving automatically backward on the contour after stop (generated by user or error condition)
  - Consideration of laser on/off delays (to avoid uncut lines)
  - Automatic retraction of the Z-axis
  - Manual movement of the axes for service or maintenance
  - Consideration of several safety issues during stop (e.g. doors, gas etc.)
  - Continue automatically from last cutting position
  - Switch on/off functions and selection of the correct cutting parameters
- Complex C2C (contour to contour) handling
  - Selectable motion types between the contours (without stroke, square, frogjump, ramp)
  - Gas is saved by switching the supply off where possible during C2C movement
  - C2C handling in compile cycles to improve productivity

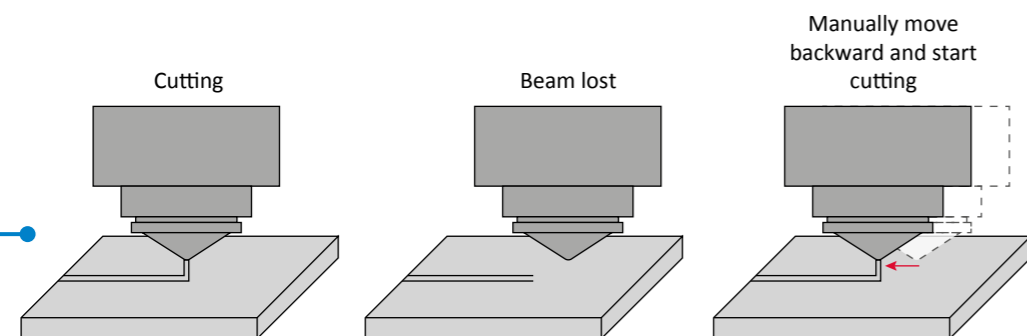

- Gas usage and laser working time are monitored and reported to the machine operator
- Job start at part or contour (needs adjustments in the postprocessor of the CAD/CAM system)
  - Selecting the part/contour by touching on screen or by tapping the next button
  - Selection by typing in the part number or contour number
  - Continue at last cut contour
- Nozzle clean function – Nozzle can be cleaned on a brush mounted on the machine. The cleaning process can be triggered manually or automatically after a definable number of cuts
- Cut single parts from the job by defining start and end part. The part(s) will be cut at a defined place on the sheet
- Retry function – automatic restart of the program after it was stopped (paused) by a lower priority error like Tiptouch
- Lead-in ramp - ramping of height during lead in movement

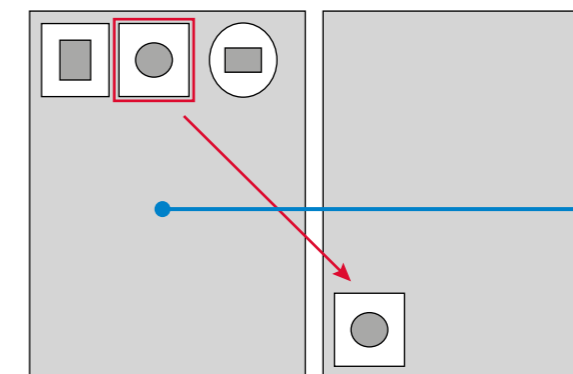

# Machine functions For laser cutting

## Advanced functions

The package has some advanced functions which allow a fast and precise cutting process.

- Fly/fast-cut
- Pipe/tube cutting
  - For pipe cutting, Inovance uses barrel cam transformation by the CNC
  - The barrel cam transformation has two functions:
    - If the CAD/CAM gives two linear axes positions the transformation makes one linear and one round axis out of it
    - The required feed for the round axis which cannot be given by the CAD/CAM is automatically calculated by the CNC

- Linearization of the cutting head
  - Each cutting head allows linearization of the analog signal from the capacitive sensor. This is mandatory for correct height regulation. The CNC can do this internally, which is both faster and safer

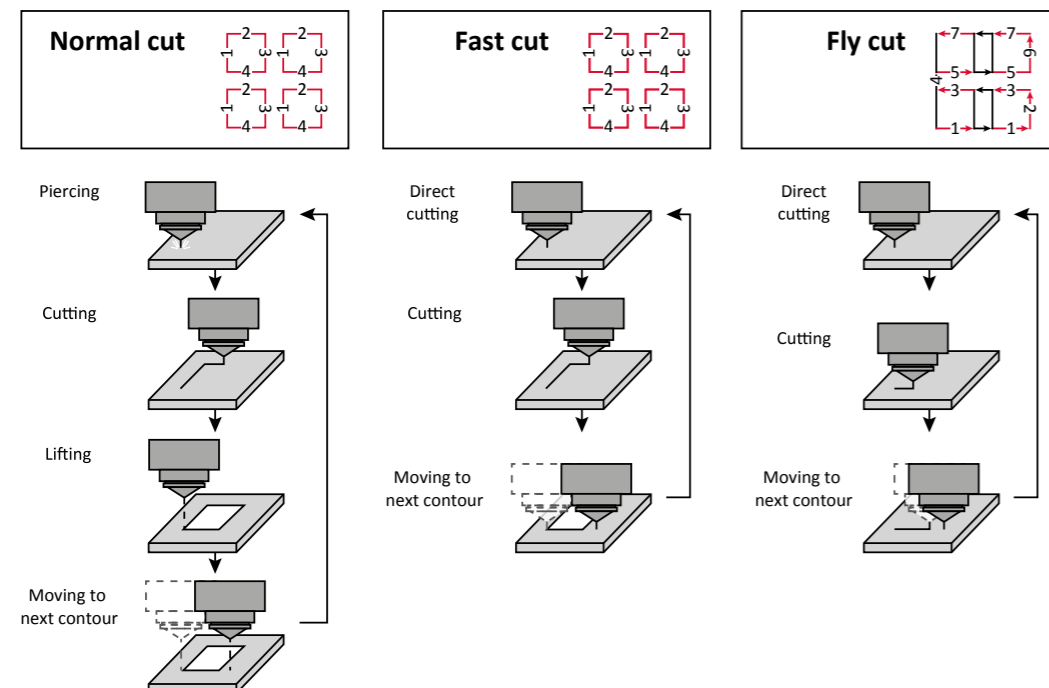

- Pulse Width Modulation
  - PWM allows a programmable laser modulation mode. That means that the laser beam is modulated either by programming the frequency and duty cycle or on-time and duty cycle. There are many advantages especially for thicker materials, the modulation helps to reduce material splash back from the piercing hole, so the lenses are protected. There is also less heat impact on the material
  - PWM modulation also allows another type of laser power control. Instead of changing the laser power while increasing or decreasing the feed (laser power control function) the laser beam is modulated. The modulation of the laser beam is much more dynamic. Therefore, the contour is cut with higher quality or is cut faster with the same quality
  - The time stamp function of the CNC in combination with PWM allows exact position related outputs (fly cut).
  - All these functions can be combined with each other

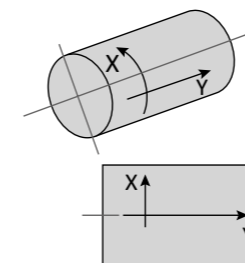

The linear movement of the X-axis is internally transformed to the round axis movement (A-axis)

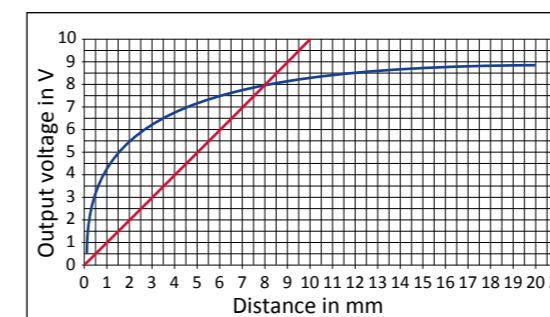

Linearization: red line linearized, blue line non-linearized

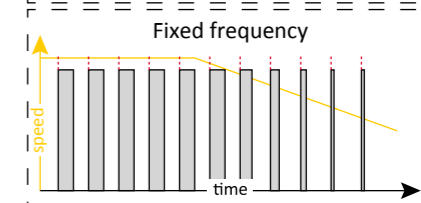
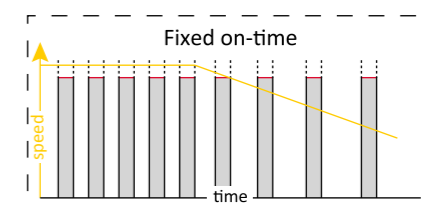
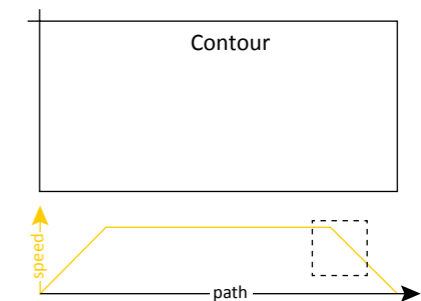

## Machine functions For laser cutting

### Advanced functions

- Exact position related output signal with fast output
  - The CNC guarantees (independent of speed and acceleration) that the laser beam is switched on or off when the programmed position is reached. Switching can also be done between CNC cycles
    - This function allows fast/fly cutting as described above
    - For this function, Inovance developed dedicated hardware to guarantee the highest performance (PASIO+ PWM)
- Laser diagnostics
  - As Inovance's CNCs are PC-based systems the laser diagnostic tools can run directly on the CNC system
- Adaptive distance regulation
  - Distance regulation allows functionality such as height regulation above the workpiece. It keeps the distance to the sheet constant during cutting even if the sheet is not flat
    - Distance regulation needs an external analog signal from a distance or height sensor. In its simplest form, distance regulation can influence the position of an axis for height control
- Cutter compensation look ahead
  - Cutter compensation look ahead is an extension of the standard cutter compensation. Multiple blocks (standard values: 10, 25, 100) can be looked at in advance to detect and avoid collisions. Different adjustments are possible for reaction to the detection of a collision: e.g. generate a message but keep executing, or take a shortcut to avoid contour damage. Cutter compensation look ahead can also execute NC programs with dummy blocks (blocks without movement information) which normally only works in special cases

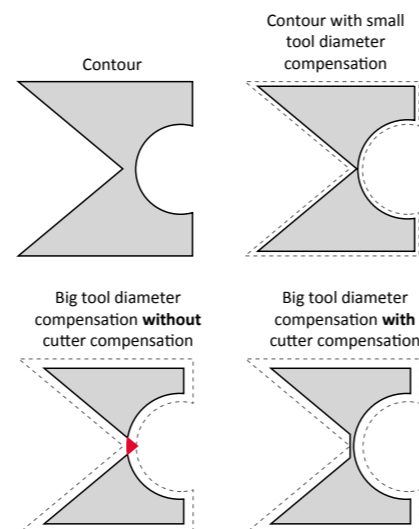
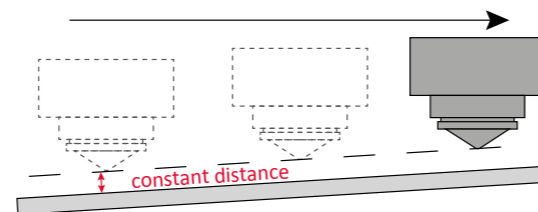
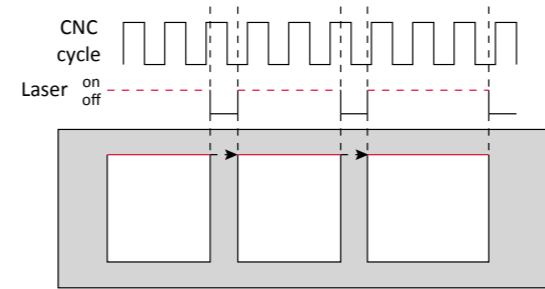

## PLC For laser

In every PA9000 CNC, Inovance provides a ready to use standard PLC program. With the PA Standard PLC, you can easily implement your own functions and peripherals.

### PLC app library

Inovance also offers a PLC app library for many of the functions and peripherals that are regularly used in laser machines. These apps are programmed for use with the standard PLC, but because of the fixed defined input/output interface of every app, they can be used in any PLC.

### Examples of PLC apps

#### Door handling app

This app can be used to handle both the locking and the up/down movement of the main doors. Additionally, it implements checks to limit speed in a running NC job with open doors.

#### Job repeat app

This app allows the machine to automatically run through a pre-created job list, handling start positions and number of repetitions. There is an option for simple nesting, and an interface to stop the machine if external handling is necessary.

#### Laser sources app

App that handles the digital and analog interface to different laser sources.

#### Laser head app

App that handles the digital and analog interface to different laser heads. Includes all options necessary for laser head handling including calibration, setting working height, freezing HSU, reading diagnostic data, and options to set focal position and image ration collimation.

Modules can also be used for other applications, or by customers who want to create their own laser software.

# Faster. More open. More innovative.



### HMI

#### Open user interface

The HMI for laser cutting offers all relevant functions for easy and efficient operation of your laser cutting machine. It can be easily and flexibly customised and updated to meet the needs of the user. With QT technology, the HMI is both powerful and graphically attractive.

### PA soft-PLC

#### IEC61131-3 CODESYS®

The turn-key solution comes with a pre-programmed PLC which features all the functionality needed for a standard laser cutting machine such as: start and stop handling, drive handling, error message handling, shuttle table logic and security functions. Most of the interfaces for common laser manufacturers and cutting heads are already included, making integration as easy as possible.

### SQL database

#### For laser cutting parameters

To store all necessary parameters for the cutting process, the software package includes an SQL-based database. In the database you can add parameters such as material, thickness and a part number, to achieve perfect cutting results, with easy, reliable operation.

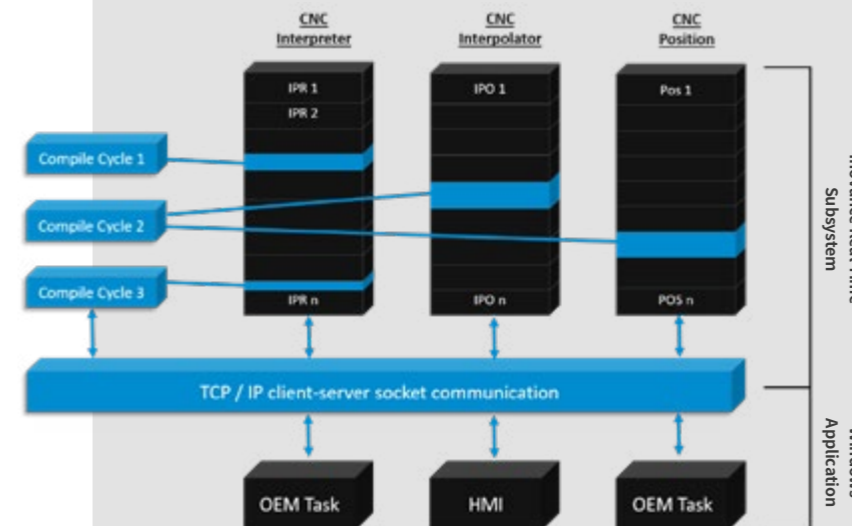

### Compile-cycles

#### It has never been easier to integrate your machine expertise into the CNC

PA compile-cycles allow you to integrate your own routines using DLLs into the real-time kernel of the Invoence CNC. Unlike other CNC manufacturers, you need not share your knowhow but can operate independently. You do not even need a special development environment as PA compile-cycles are written in programming language C.



# Sample Configuration

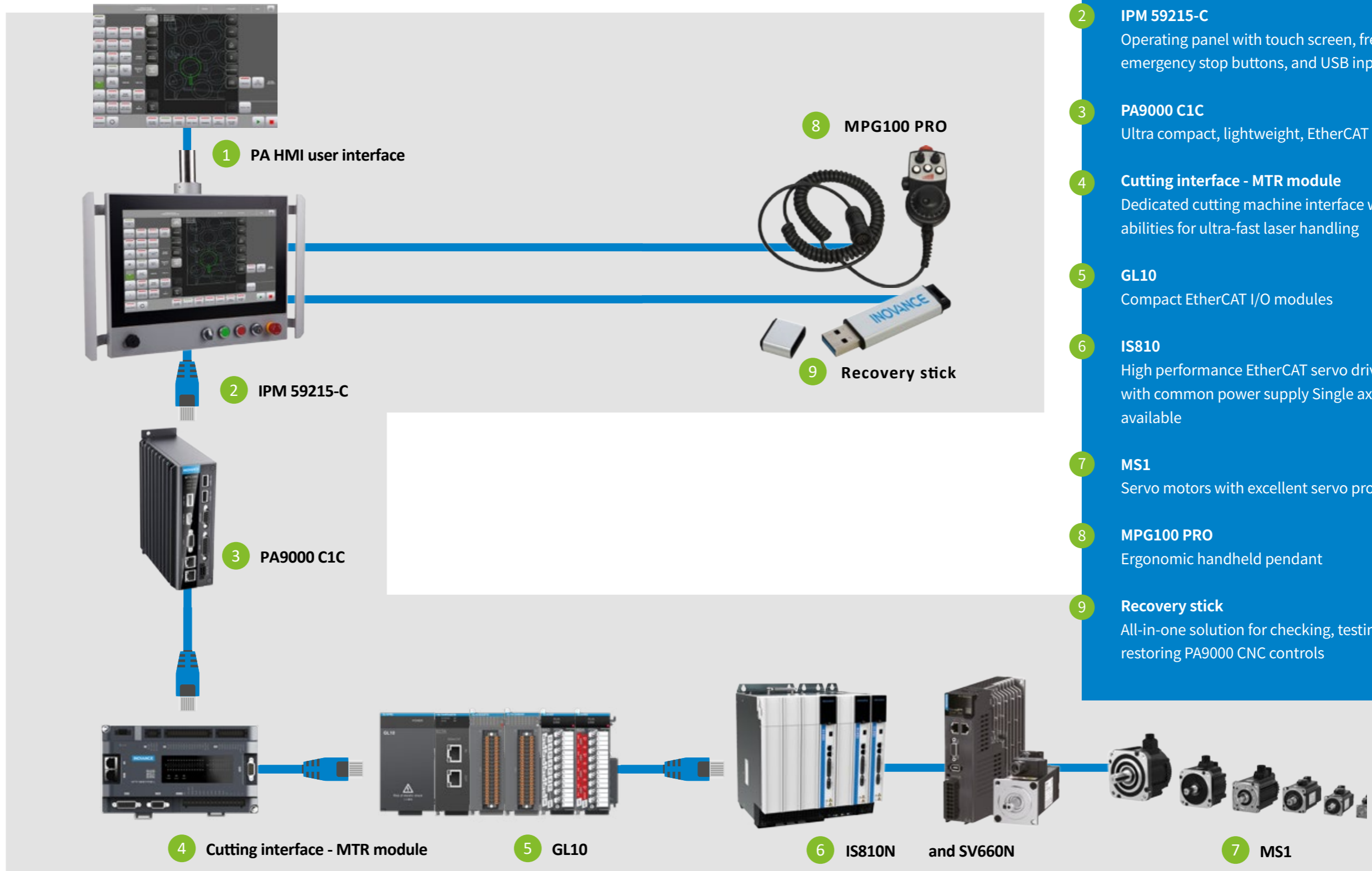

- 1 **PA HMI user interface**  
State of the art design. Easy-to-use
- 2 **IPM 59215-C**  
Operating panel with touch screen, freely definable emergency stop buttons, and USB input
- 3 **PA9000 C1C**  
Ultra compact, lightweight, EtherCAT CNC
- 4 **Cutting interface - MTR module**  
Dedicated cutting machine interface with synchronous abilities for ultra-fast laser handling
- 5 **GL10**  
Compact EtherCAT I/O modules
- 6 **IS810**  
High performance EtherCAT servo drives 400 V series with common power supply Single axis versions also available
- 7 **MS1**  
Servo motors with excellent servo properties
- 8 **MPG100 PRO**  
Ergonomic handheld pendant
- 9 **Recovery stick**  
All-in-one solution for checking, testing, recovering and restoring PA9000 CNC controls



# Driven by Technology

AC Drives



AC MultiDrives



MV Drives



Single-Axis Servos



Multi-Axis Servos



Robotics & Motion Controllers



PLCs & HMIs



CNC Machine Tool Solutions



Electric Vehicle Inverters



For more information, please contact our local offices.

## International Offices

### Germany-Stuttgart

Tel: +49 (0) 7144 8990  
sales.de@inovance.eu

### Italy-Milano

Tel: +39 (0) 2268 22318  
sales.it@inovance.eu

### France-Bordeaux

Tel: +33 (0) 5594 01050  
sales.fr@inovance.eu

### Turkey-Istanbul

Tel: +90 (216) 706 17 89  
info@inovance.eu

### South Korea-Seoul

Tel: +82 (0) 10 7428 5732  
info@inovance.eu

### India

**Head Office Chennai**  
Tel: +91 (0) 44 4380 0201

### Ahmedabad

Tel: +91 794003 4272

### Mumbai

Tel: +91 22 4971 5883

### New Delhi

Tel: +91 11 4165 4524

**Sales Network** in Kolkata, Bengaluru, Pune,  
Coimbatore, Hyderabad, Vadodara, Jaipur  
Email: info@inovance.ind.in

### Hong Kong SAR

## International Export Office

**Tel: +852 2751 6080**  
**info@inovance.eu**

For other country distributors,  
contact the Hong Kong office.

### Inovance Technology Companies

Shenzhen Inovance Technology Co. Ltd.  
Suzhou Inovance Technology Co. Ltd.

**INOVANCE**  
[www.inovance.eu](http://www.inovance.eu)